

**DESIGN COPYRIGHT – 07/26/2022**  
**ALL RIGHTS RESERVED AND MAY**  
**NOT BE DUPLICATED WITHOUT OUR**  
**WRITTEN PERMISSION**

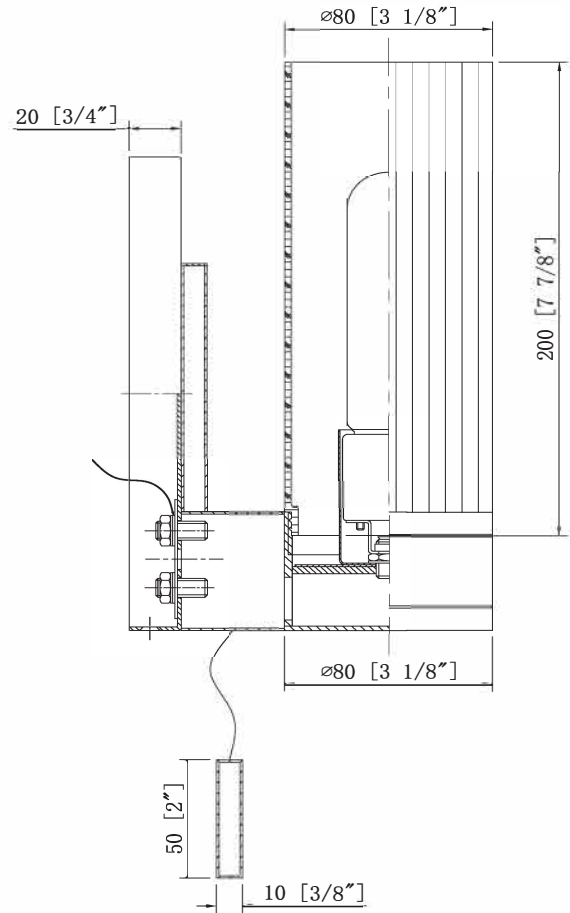
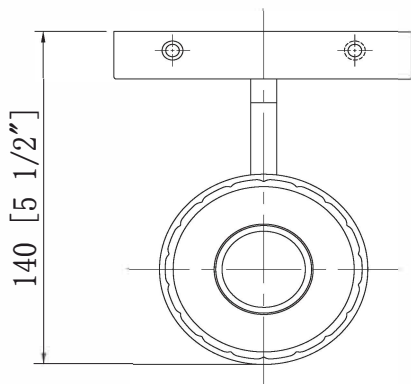
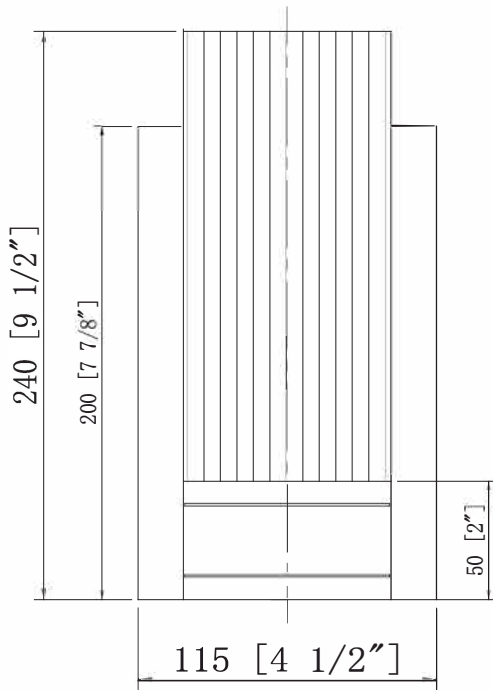
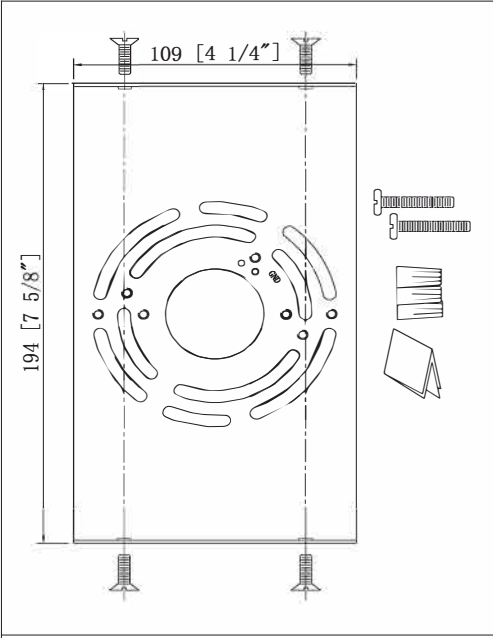

**ITEM: 429-1W-8**